

# SLIM RAPID

## CERNIERE PER PORTE REGISTRABILE CON PIASTRINA AD INFILARE

CERNIERA PER PORTE REGISTRABILE CON PIASTRINA AD IN FILARE | ADJUSTABLE DOOR HINGE WITH THREADED PLATE | PAUMELLE POUR PORTES REGLABLE AVEC PLAQUE A ENFILER | BISAGRA PARA PUERTAS REGULABLES CON PLACA A INSERTAR



Cerniera e piastrine in alluminio estruso; perno, viti e grani in acciaio inox; boccia e rondelle in nylon.



Hinge and plates in extruded aluminum; stainless steel pin, screws and setscrews; nylon bushing and washers.



Paumelle et plaques en aluminium extrudé; pivot, vis et grains en acier inox; bague et rondelles en nylon.



Bisagra y placas de aluminio extruido; pernio tornillos y prisioneros de acero inox; casquillo y arandelas de nylon.



### CONFEZIONAMENTO E FINITURE | PACKAGING AND FINISHES | CONDITIONNEMENT ET FINITIONS | EMBALAJE Y ACABADOS

ART.	TUTTI   ALL   TOUS   TODOS
Imballo   Package   Conditionnement   Embalaje	2 Pz
Finiture disponibili   Available finishes Finitions disponibles   Acabados disponibles	1 2 3 4 5 6

ESTRUSORE   EXTRUDER	SERIE   SERIES	DUE ALI	TRE ALI
	Camera Europea Euro Groove	8060	8060.6
ALCAN	Abithal Point	8063	8063.6
ALLU SISTEMI	RX 600	8061	8061.6
	RX 700	8061	8061.6
CLL	Tecno 50	8061	8061.6
	Tecno 50 TT	8061	8061.6
	Tecno 60 TT	8061	8061.6
	Tecno 68 TT	8061	8061.6
EKU Sistemi (Gruppo Profilati)	Sistema 1 sorm.	8063	8063.6
ETNALL	ET 43	8063	8063.6
	TT 50	8061	8061.6
	TT 50 3° anta	8062	8062.6
IBLEA COLOR GROUP	Eku Vuerre 40	8063	8063.6
INDINVEST	Wing 40	8063	8063.6
METRA	NC 45 Int.	8064	8064.6
	NC 45 STH	8064	8064.6
	NC 50 Int.	8064	8064.6
	NC 50 STH	8064	8064.6
	NC 65 STH	8064	8064.6
	NC 68 STH	8064	8064.6
	NC 72 STH	8064	8064.6
	Nuovo NC 40 sorm.	8063	8063.6
	PRESAL EXTRUSION	PR 66 tt	8061
PR 75 tt		8061	8061.6
PR 80 tt		8061	8061.6
PONZIO	Newtec 50	8061	8061.6
	Newtec 52 TT	8061	8061.6
	Newtec 60 TT	8061	8061.6
	Newtec 68 TT	8061	8061.6
SAPA	Erre 40	8061	8061.6
	Erre 40 3° anta	8062	8062.6

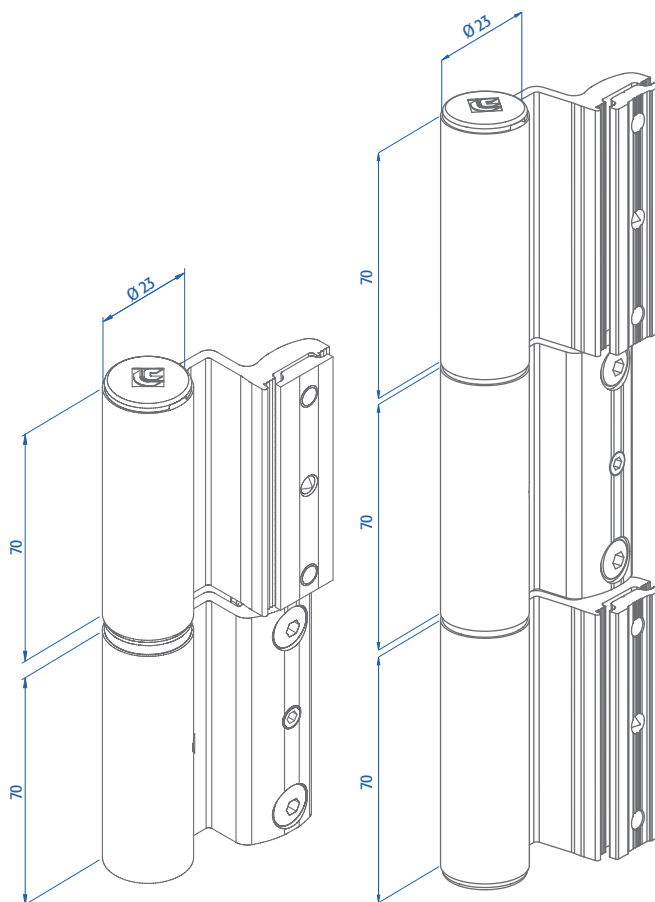

CONTINUA | CONTINUES | CONTINUE | CONTINÚA >

< SEGUE DALLA PAGINA PRECEDENTE | CONTINUED FROM PREVIOUS PAGE | SUIT DE LA PAGE PRECEDENTE | CONTINÚA DE LA PÁGINA ANTERIOR

ESTRUSORE   EXTRUDER	SERIE   SERIES	DUE ALI	TRE ALI
SAPA	Erre 50 TT b.c.	8061	8061.6
	Erre 50 TT b.c. 3° anta	8062	8062.6
	Erre 62 TT	8061	8061.6
	Erre 62 TT 3° anta	8062	8062.6
	Erre 72 TT	8061	8061.6
	Erre 72 TT 3° anta	8062	8062.6
TOMA	Atlantis 40	8063	8063.6

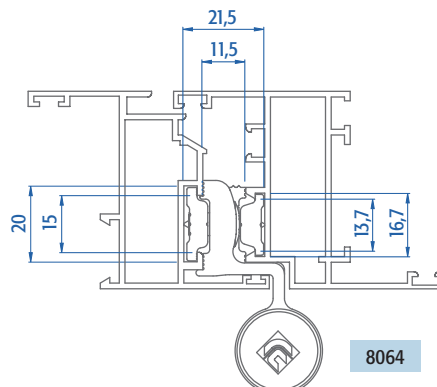
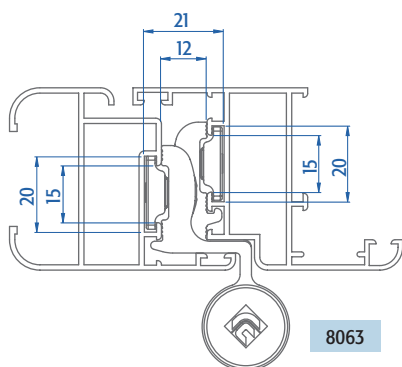
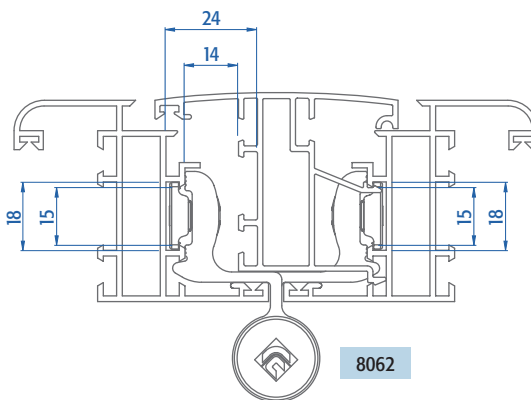
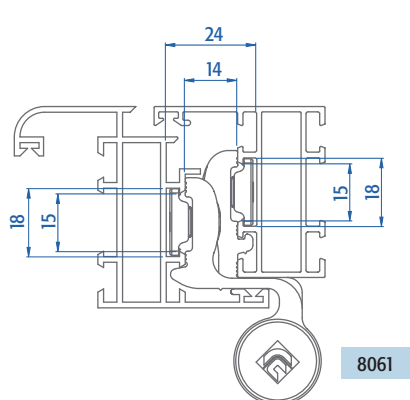
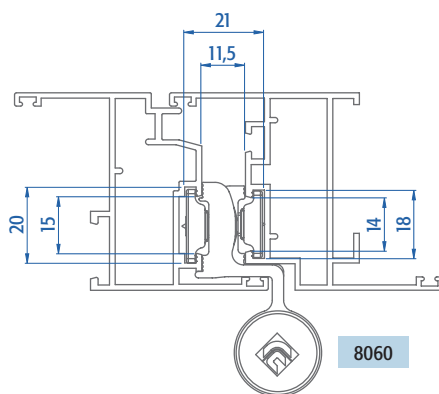

CONTINUA | CONTINUES | CONTINUE | CONTINÚA >

Slim Rapid 806X

H	3000	100%	100%	100%	100%	100%	100%	100%	100%	100%	100%	100%	H>2600 Utilizzare Quarta Cerniera di allineamento.	
	2900	100%	100%	100%	100%	100%	100%	100%	100%	100%	100%	81%		
	2800	100%	100%	100%	100%	100%	100%	100%	100%	100%	100%	75%		
	2700	100%	100%	100%	100%	100%	100%	100%	100%	100%	80%	69%		
	2600	100%	100%	100%	100%	100%	100%	100%	100%	100%	73%	63%		
	2500	100%	100%	100%	100%	100%	100%	100%	100%	79%	67%	56%		
	2400	100%	100%	100%	100%	100%	100%	100%	85%	71%	60%	50%		
	2300	100%	100%	100%	100%	100%	100%	100%	77%	64%	53%	50%		
	2200	100%	100%	100%	100%	100%	100%	83%	69%	57%	50%	50%		
	2100	100%	100%	100%	100%	100%	100%	75%	62%	50%	50%	50%		
	2000	100%	100%	100%	100%	100%	82%	67%	54%	50%	50%	50%		
	1900	100%	100%	100%	100%	100%	73%	58%	50%	50%	50%	N.D.		
	1800	100%	100%	100%	100%	80%	64%	50%	50%	50%	N.D.	N.D.		
	1700	100%	100%	100%	100%	70%	55%	50%	50%	50%	N.D.	N.D.		
	1600	100%	100%	100%	78%	60%	50%	50%	50%	N.D.	N.D.	N.D.		
		600	700	800	900	1000	1100	1200	1300	1400	1500	1600		
		L												

L>1200 Utilizzare Terza Cerniera.

Indipendentemente dal peso della porta, per porte sottoposte ad un intenso utilizzo come nel caso di edifici aperti al pubblico, porte con chiudiporta o porte ad azionamento motorizzato il limite di impiego è limitato a H 2400 e L 1000 con l'utilizzo della terza o quarta cerniera (cerniera blu) come da diagramma. Whatever the door weight, doors subject to heavy duty, such as public building, doors with closers or automatic doors have a limited range of application limited to H 2400 and L 1000 and must be fitted with an addition hinge (blue hinge) as in the diagram.

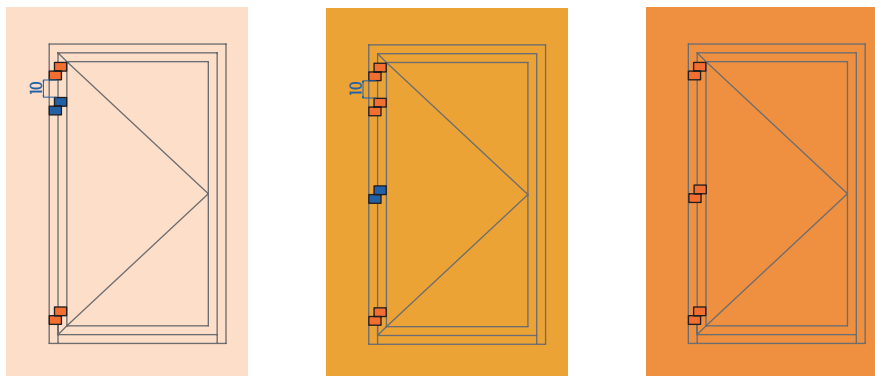

ART.	PORTATA LOAD CAPACITY
8060; 8063; 8064	100% = 120 Kg
8061; 8062;	100% = 100 Kg
8060.6; 8063.6; 8064.6	100% = 160 Kg
8061.6; 8062.6	100% = 140 Kg

- Esempio
1. Dim. LxH (WxH) 1200x2300 = 100% Portata 2 cerniere (Load Capacity 2 hinges)
  2. Dim. LxH (WxH) 1600x2200 = 50% Portata 3 cerniere (Load Capacity 3 hinges)
  3. Dim. LxH (WxH) 1400x3000 = 100% Portata 4 cerniere (Load Capacity 4 hinges)

I diagrammi hanno validità per spessore profili (Load charts is for profiles thickness) ≥ a 1,5 mm